

AUFNAHME (Ansicht auf Verdrahtungsebene)

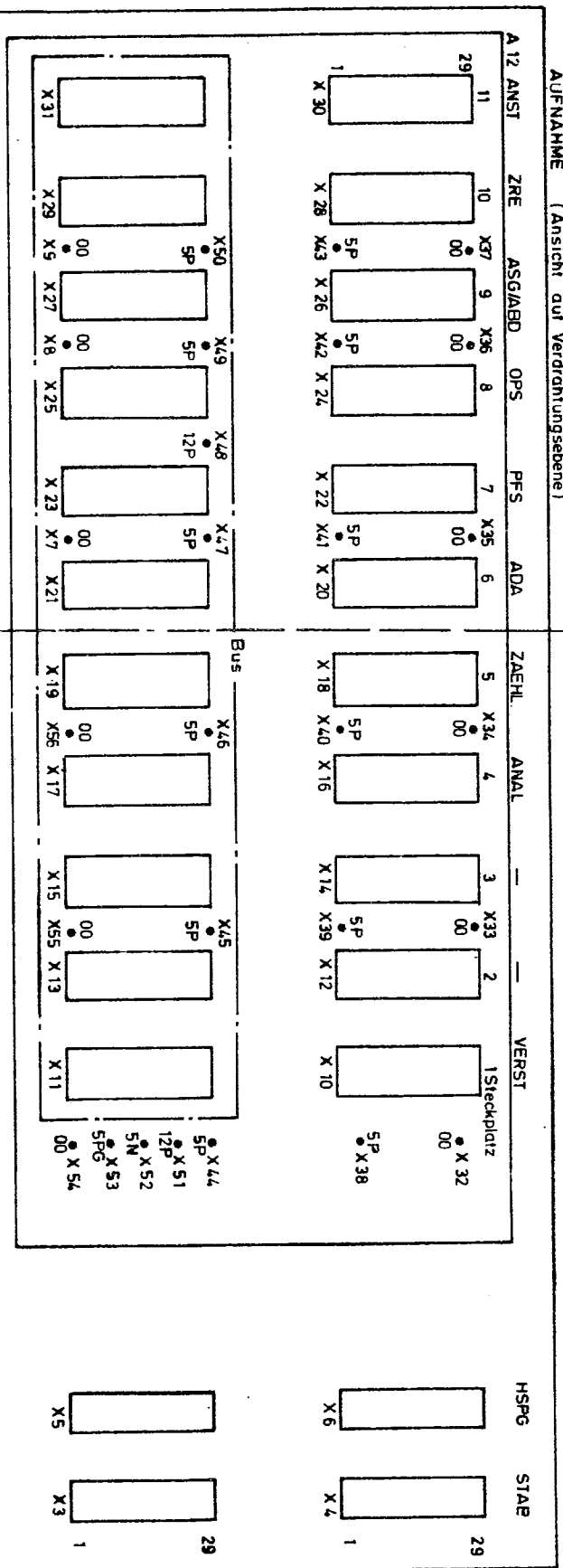

X 100
Lage der Hauptbaugruppen
(Ansicht von oben, ohne Abdeckung)
(Baustein A 3) (Baustein A 4)

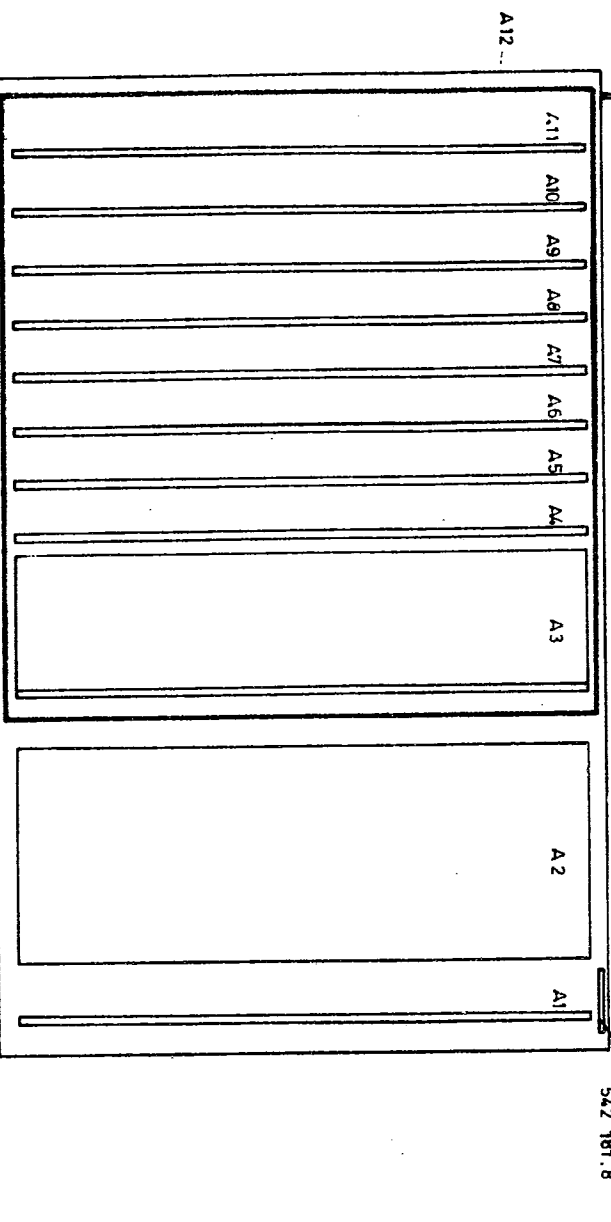

Verdrahtungsebene der Aufnahme

Ansicht auf Verdrahtungsebene (oben vergrößert dargestellt)

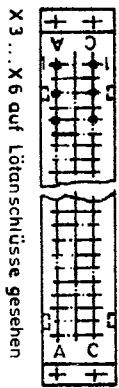
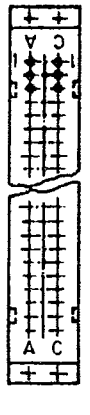
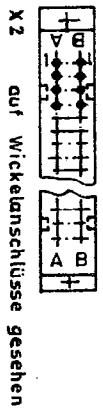
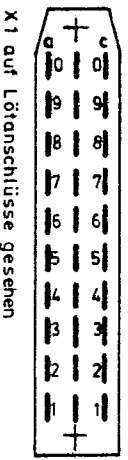
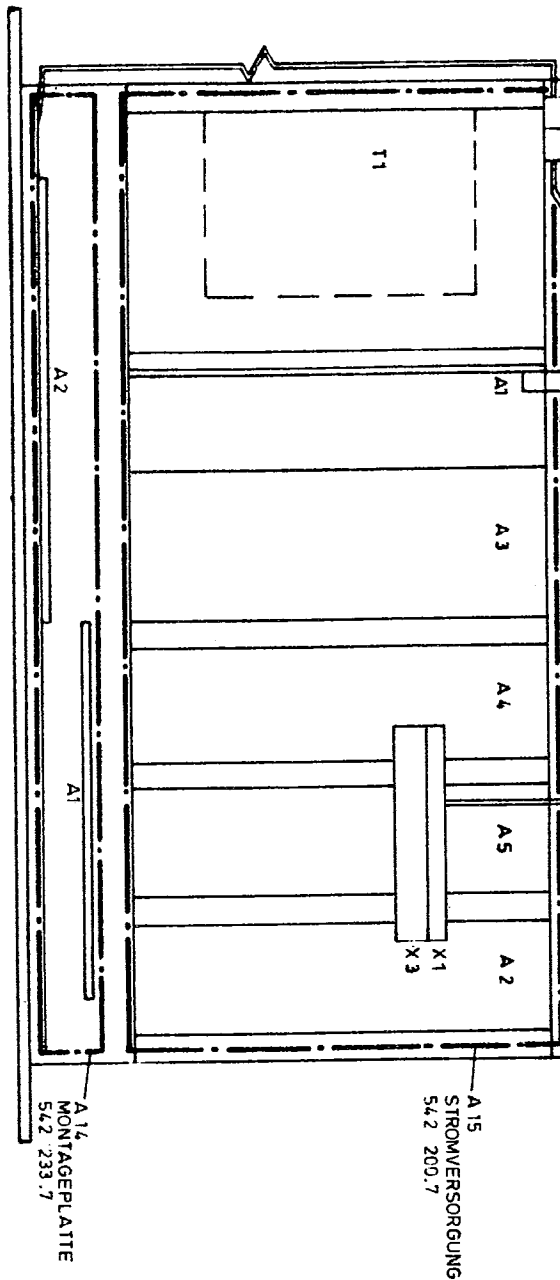
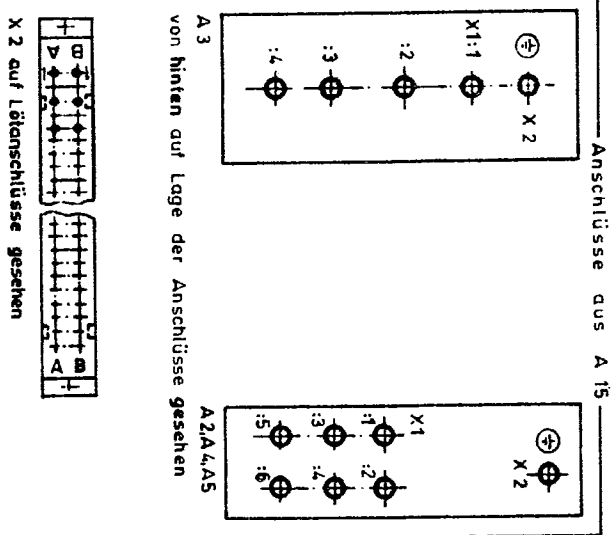

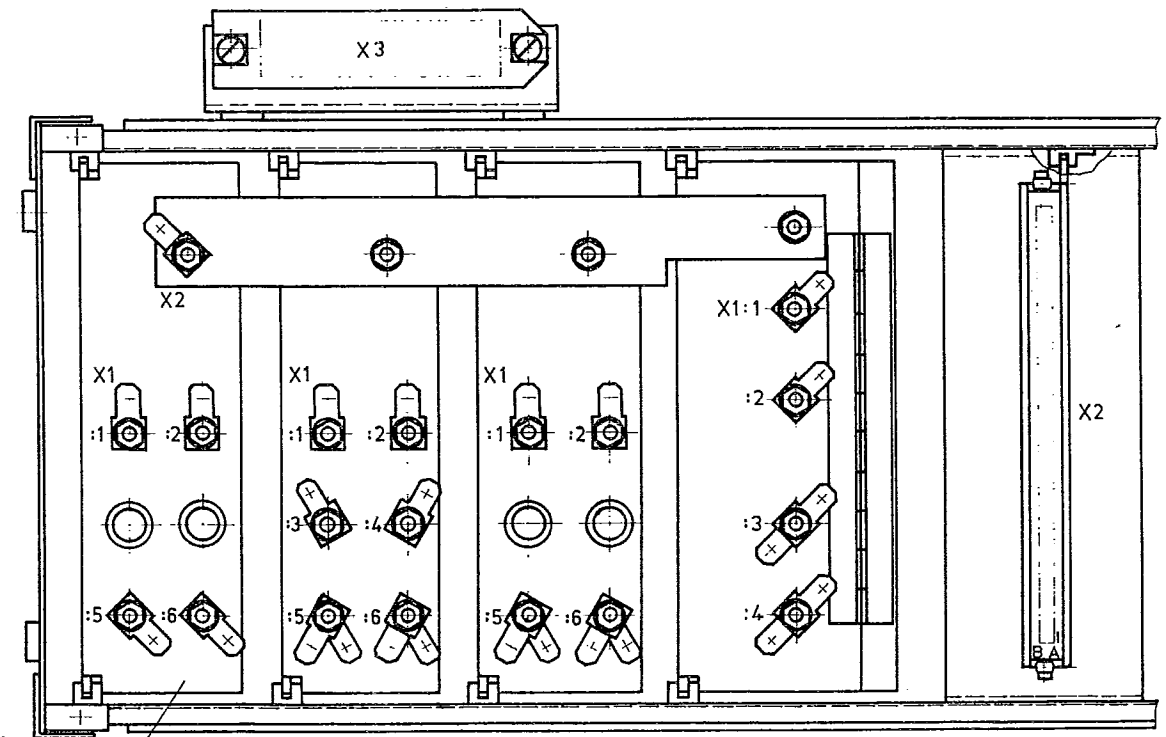
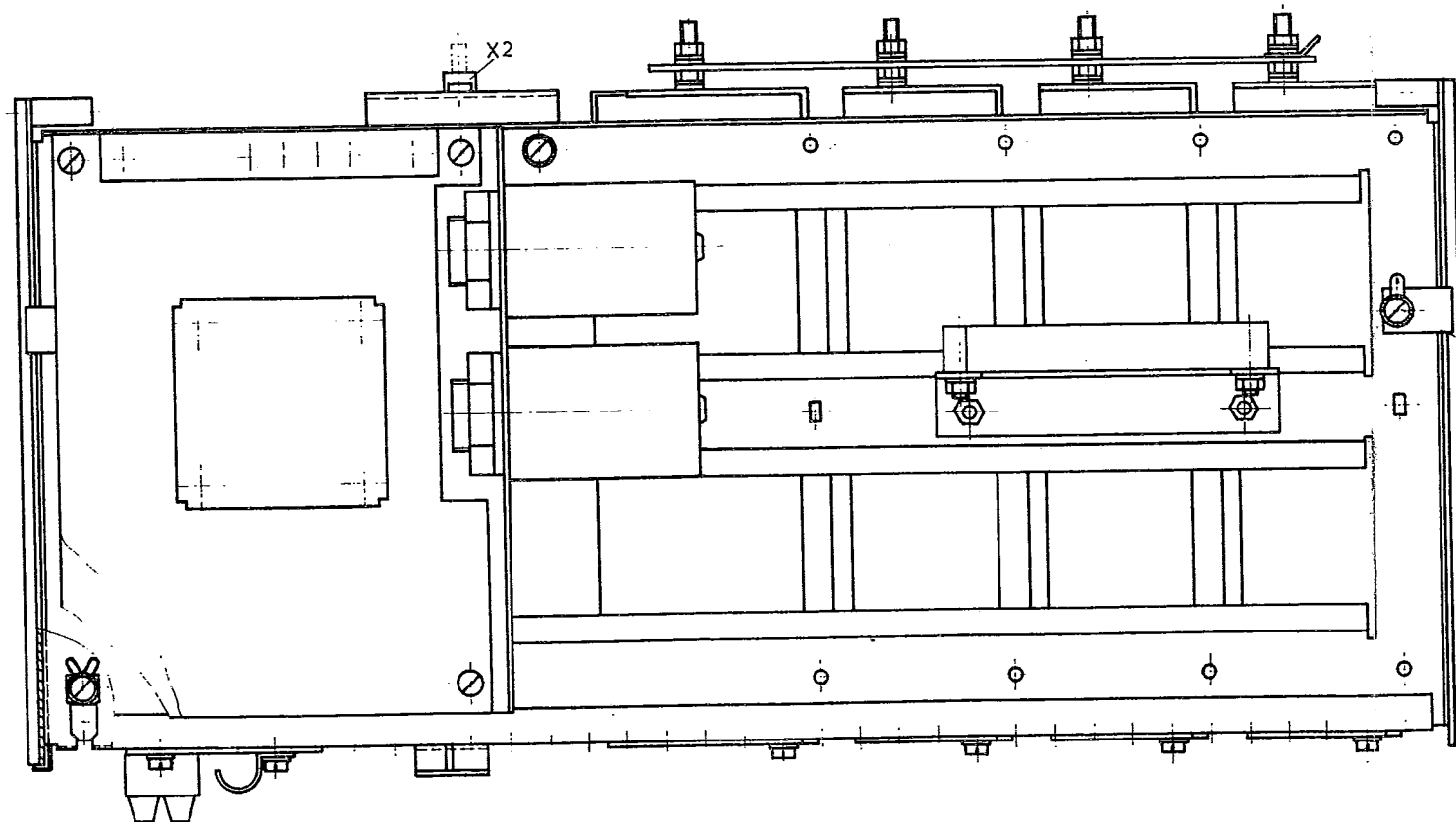
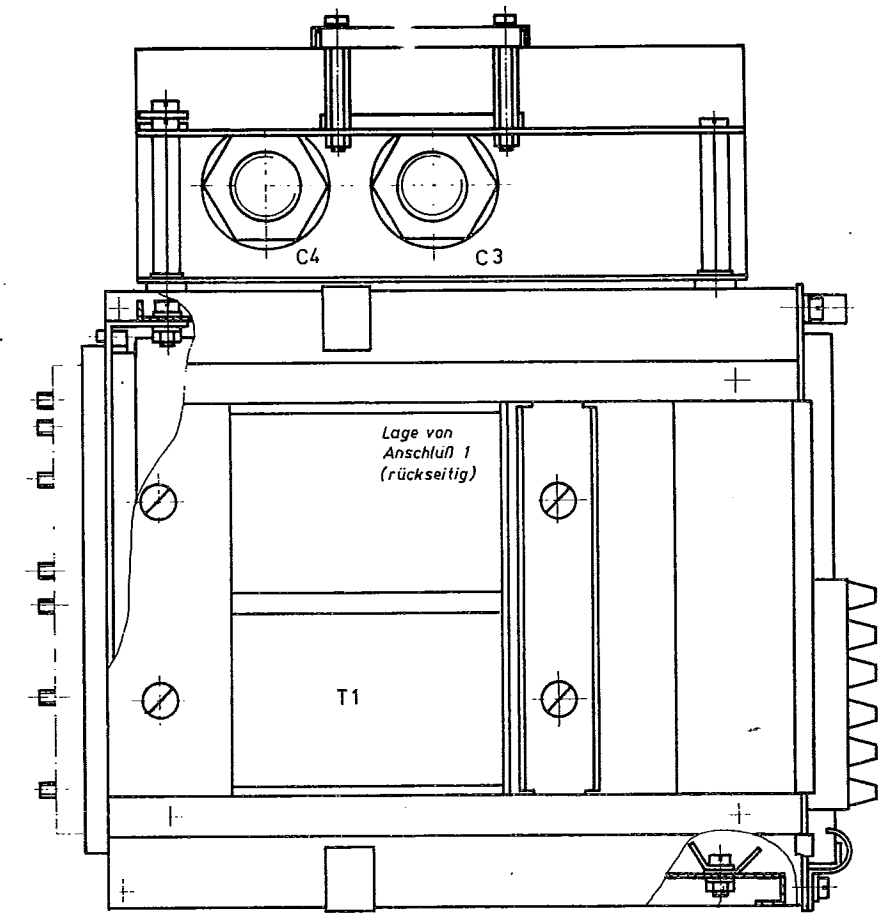
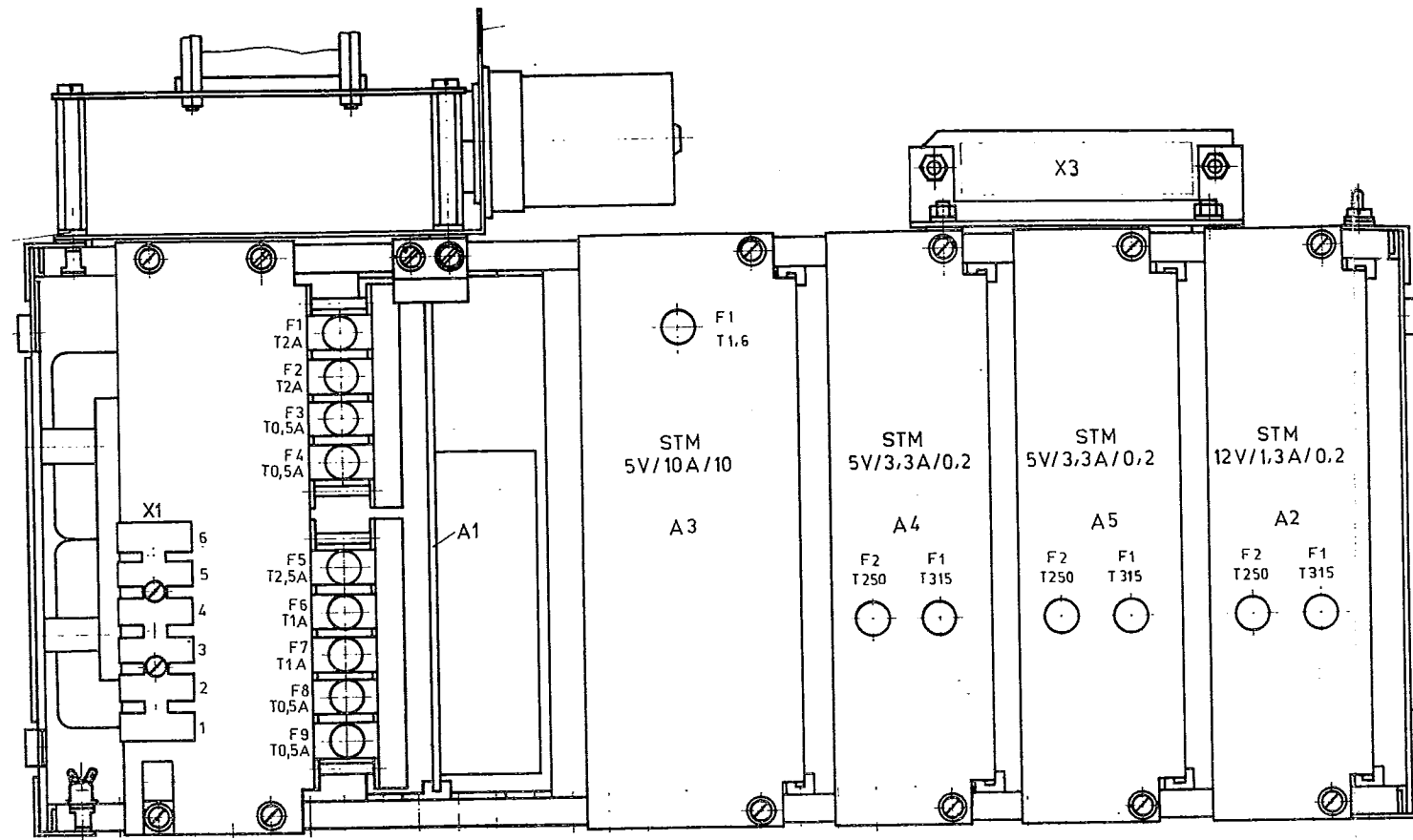

Anschlüsse siehe
20 050 Bl. 2

Position der Bauelemente
Расположение деталей
Component Location

A

542 200.7
STROMVERSÖRGUNG
БЛОК ПИТАНИЯ
POWER SUPPLY